

## OMEGAPROFIL AUF HORIZONTALLEM HUTPROFIL OMEGA SYSTEM RAIL ON HORIZONTAL HAT PROFILE RAIL SYSTEME OMEGA SUR PROFILE CHAPE HORIZONTAL

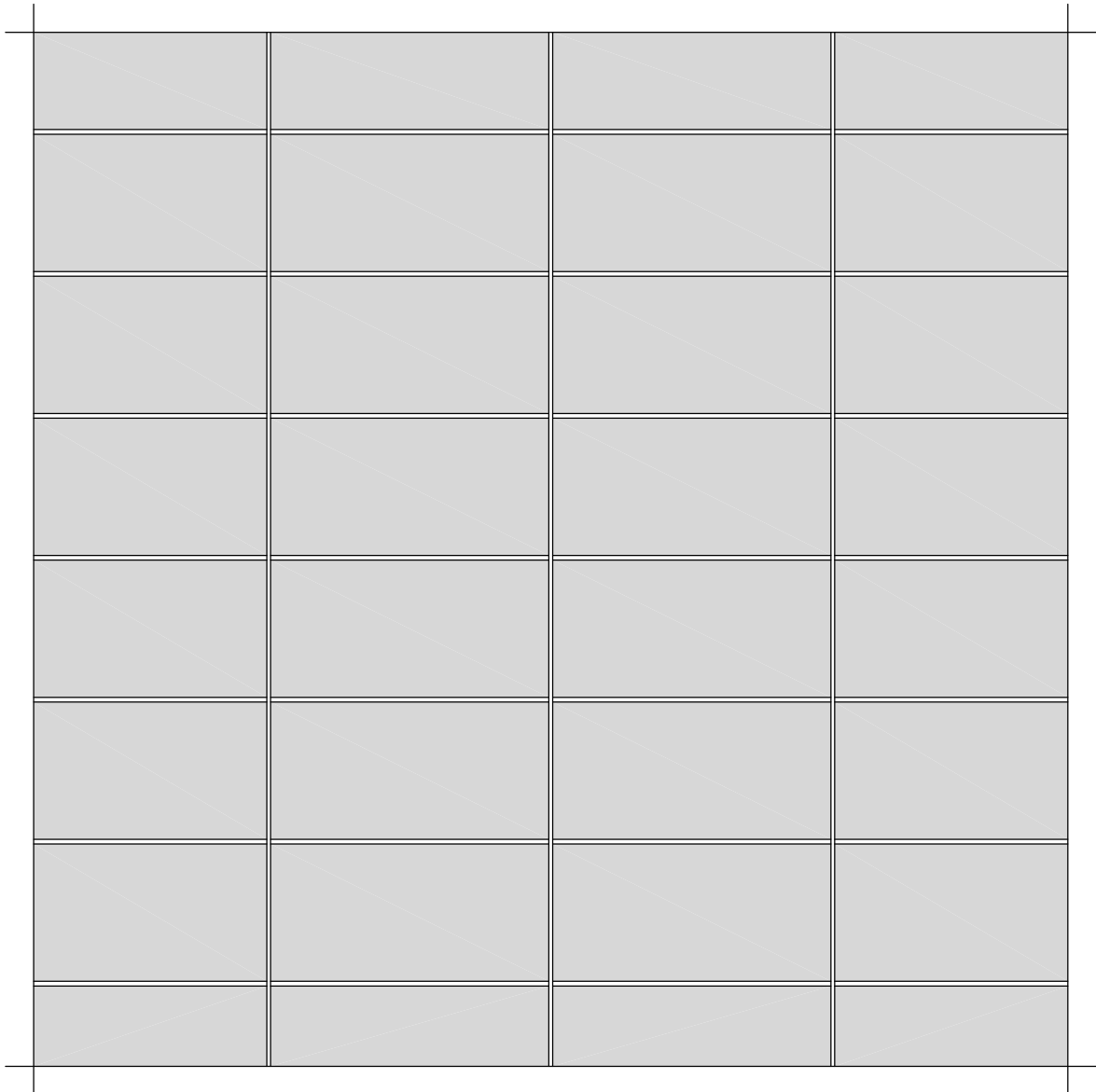

WEITERE OBJEKTSPEZIFISCHE DETAILS AUF ANFRAGE  
FURTHER PROJECT-RELATED DETAILS UPON REQUEST  
D'AUTRES DETAILS RELATIFS AU PROJET SUR DEMANDE

Alle Rechte vorbehalten. Außervertragliche Nutzung nur mit unserer schriftlichen Genehmigung.  
All rights reserved. Noncontract use is subject to our previous written consent.  
Tous droits réservés. Utilisation hors contract seulement avec notre autorisation écrite.

**DEUTSCHE STEINZEUG**  **AGROB BUCHTAL** AGROB BUCHTAL GmbH Architektenservice D - 92519 Schwarzenfeld  
Tel. 09435 / 391 3308 Fax. 09435 / 391 3442 e-mail: as.fassade@deutsche-steinzeug.de

STAND: Januar 2012

DIES SIND UNVERBINDLICHE KONSTRUKTIONSVORSCHLÄGE, DIE FÜR JEDES PROJEKT AUF ANWENDBARKEIT UND RICHTIGKEIT GEPRÜFT WERDEN MÜSSEN.  
THESE ARE NOT BINDING CONSTRUCTION PROPOSALS WHICH HAVE TO BE VERIFIED FOR EACH INDIVIDUAL PROJECT AS REGARDS APPLICABILITY AND CORRECTNESS.  
IL S' AGIT DE PROPOSITIONS DE CONSTRUCTION SANS ENGAGEMENT DE NOTRE PART QUI DOIVENT ETRE VERIFIEES POUR CHAQUE PROJET A LEUR EXACTITUDE ET FAISABILITE.

# SYSTEMÜBERSICHT

SYSTEM SCHEME

SYSTEME - VUE D' ENSEMBLE

## KeraTwin® K20

OMEGAPROFIL AUF HORIZONTAL HUTPROFIL

OMEGA SYSTEM RAIL ON HORIZONTAL HAT PROFILE

RAIL SYSTEME OMEGA SUR PROFILE CHAPE HORIZONTAL

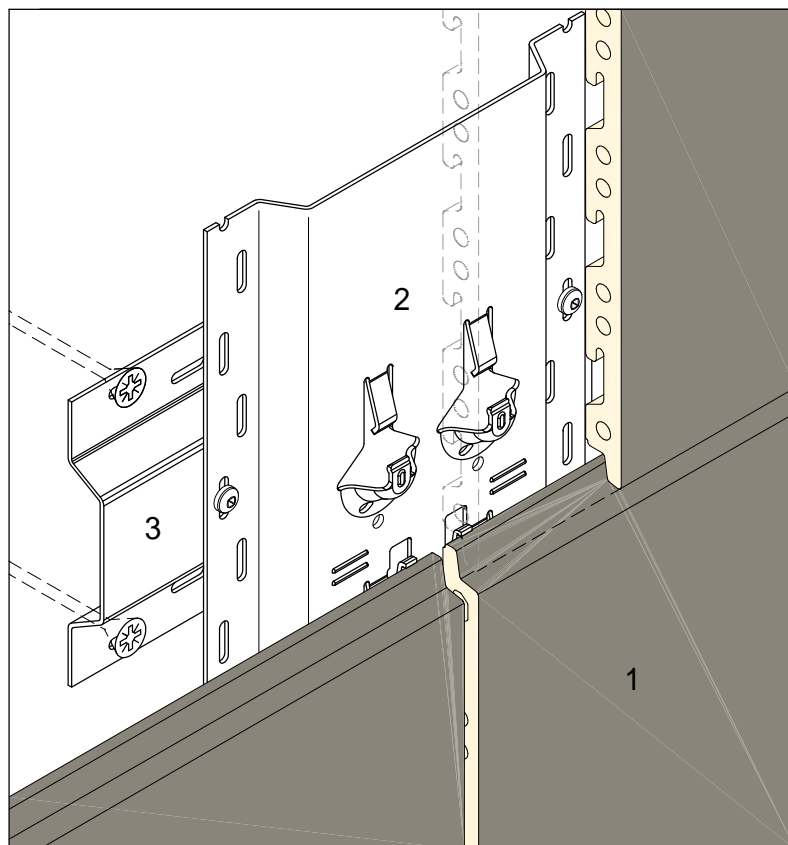

- 1 - KeraTwin® K20 - FASSADENPLATTE
- 2 - VERTIKALES OMEGAPROFIL
- 3 - HORIZONTALES HUTPROFIL

- 1 - KeraTwin® K20 - PANEL
- 2 - VERTICAL OMEGA SYSTEM RAIL
- 3 - HORIZONTAL HAT PROFIL

- 1 - DALLE KeraTwin® K20
- 2 - RAIL SYSTEME OMEGA VERTICAL
- 3 - PROFILE CHAPE HORIZONTAL

# SYSTEMSCHNITT HORIZONTAL

HORIZONTAL SECTION  
COUPE HORIZONTALE

KeraTwin® K20

OMEGAPROFIL AUF HORIZONTALLEM HUTPROFIL  
OMEGA SYSTEM RAIL ON HORIZONTAL HAT PROFILE  
RAIL SYSTEME OMEGA SUR PROFILE CHAPE HORIZONTAL

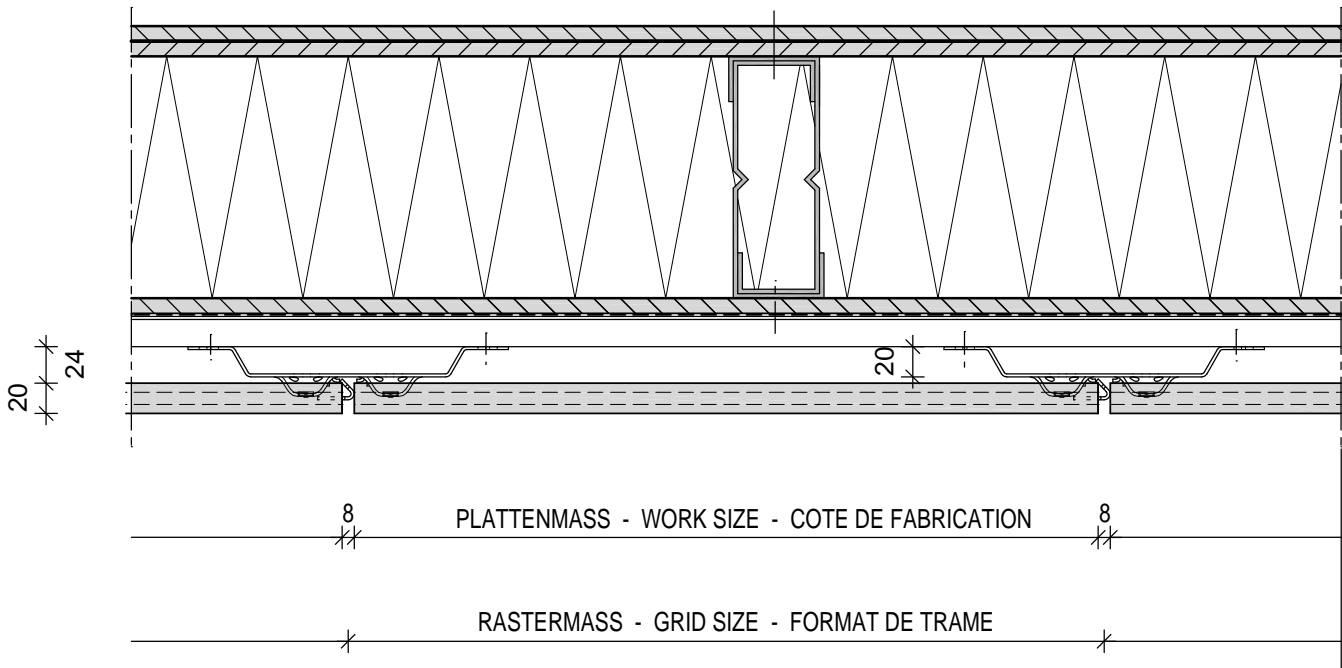

# SYSTEMSCHNITT VERTIKAL

VERTICAL SECTION  
COUPE VERTICALE

KeraTwin® K20

OMEGAPROFIL AUF HORIZONTALER HUTPROFIL  
OMEGA SYSTEM RAIL ON HORIZONTAL HAT PROFILE  
RAIL SYSTEME OMEGA SUR PROFILE CHAPE HORIZONTAL

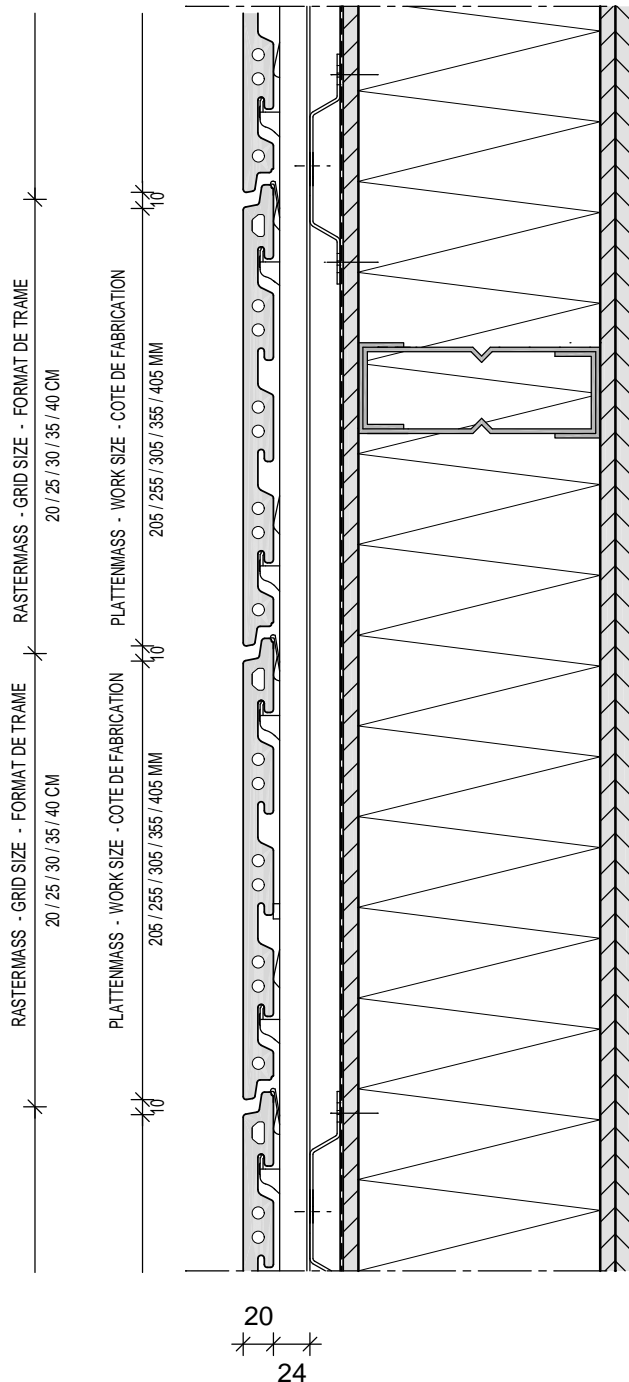

# PROFILSTOSS

BUTT-JOINT OF PROFILES  
BOUT DE PROFILE

KeraTwin® K20

OMEGAPROFIL AUF HORIZONTALM HUTPROFIL  
OMEGA SYSTEM RAIL ON HORIZONTAL HAT PROFILE  
RAIL SYSTEME OMEGA SUR PROFILE CHAPE HORIZONTAL

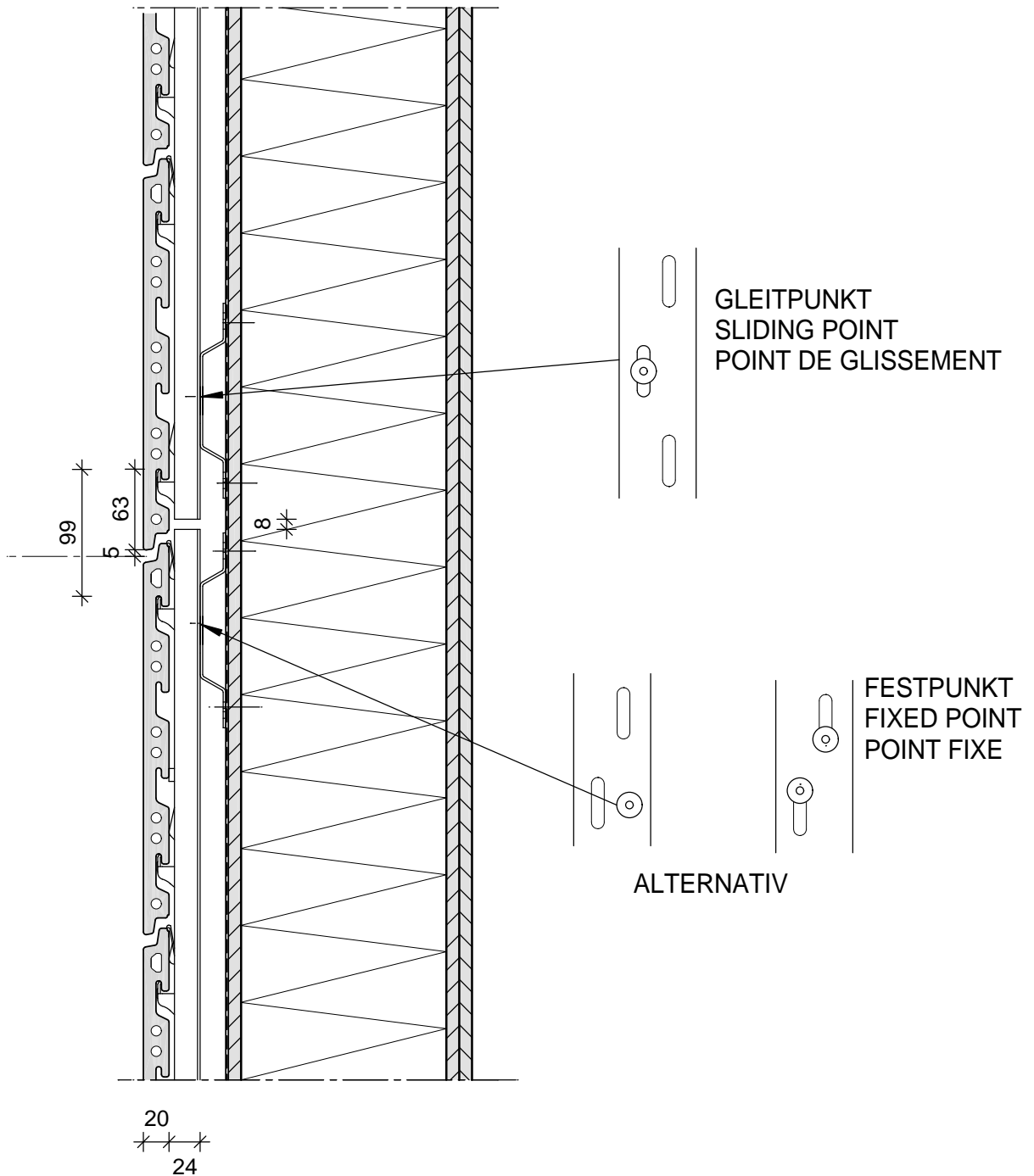

# BRANDSPERRE

FIRE BARRIER  
PARE-FEU

## KeraTwin® K20

OMEGAPROFIL AUF HORIZONTAL HUTPROFIL  
OMEGA SYSTEM RAIL ON HORIZONTAL HAT PROFILE  
RAIL SYSTEME OMEGA SUR PROFILE CHAPE HORIZONTAL

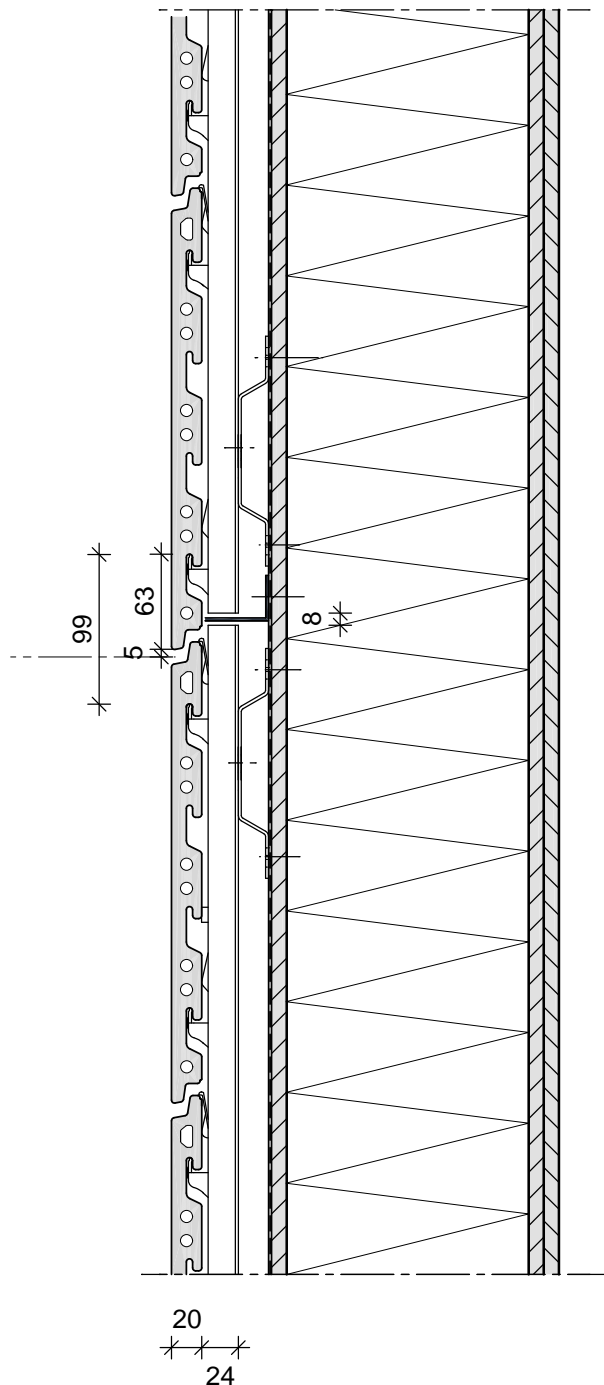

# AUSSENECKE MIT GEHRUNGSPLATTEN

EXTERNAL ANGLE WITH MITRED TILES  
ANGLE EXTERIEUR AVEC CARREAUX EN BIAIS

KeraTwin® K20

OMEGAPROFIL AUF HORIZONTALER HUTPROFIL  
OMEGA SYSTEM RAIL ON HORIZONTAL HAT PROFILE  
RAIL SYSTEME OMEGA SUR PROFILE CHAPE HORIZONTAL

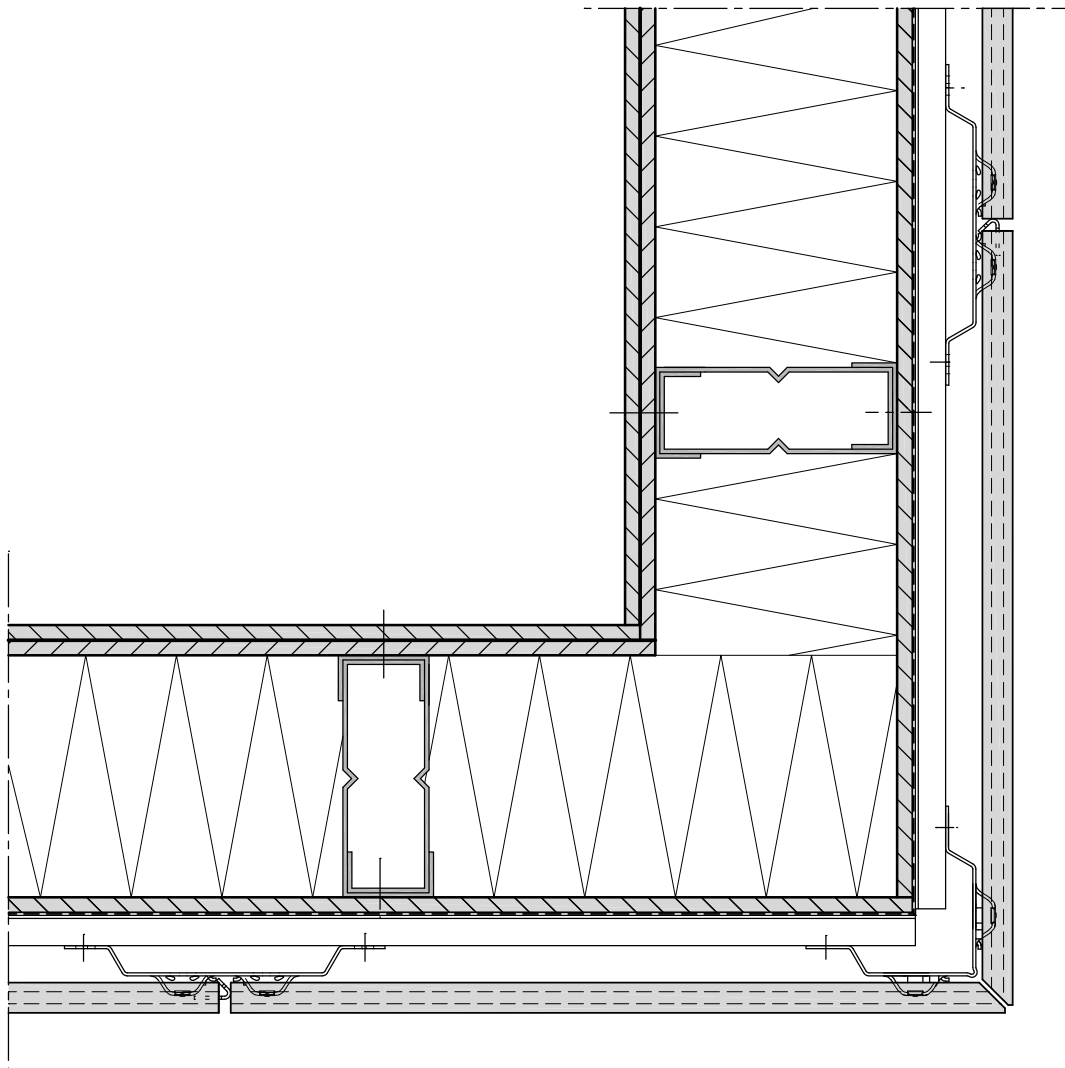

# AUSSENECKE MIT ECKPROFIL QUADRAT

EXTERNAL ANGLE WITH SQUARE CORNER PROFILE  
ANGLE EXTERIEUR AVEC PROFILE D' ANGLE CARRE

KeraTwin® K20

OMEGAPROFIL AUF HORIZONTALLEM HUTPROFIL  
OMEGA SYSTEM RAIL ON HORIZONTAL HAT PROFILE  
RAIL SYSTEME OMEGA SUR PROFILE CHAPE HORIZONTAL

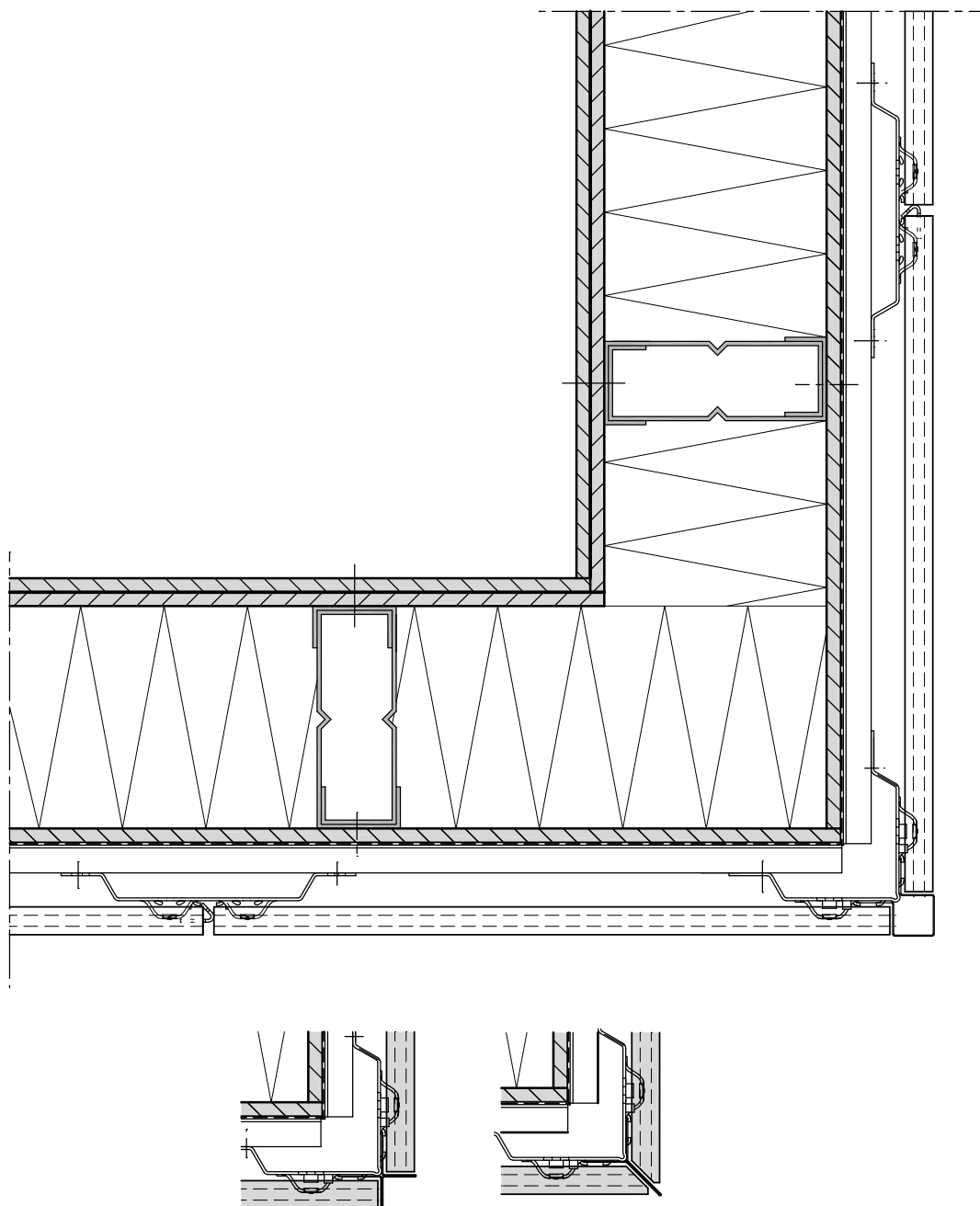



# SOCKELANSCHLUSS

CONNECTION TO PLINTH  
RACCORD DE SOCLE

KeraTwin® K20

OMEGAPROFIL AUF HORIZONTALM HUTPROFIL  
OMEGA SYSTEM RAIL ON HORIZONTAL HAT PROFILE  
RAIL SYSTEME OMEGA SUR PROFILE CHAPE HORIZONTAL

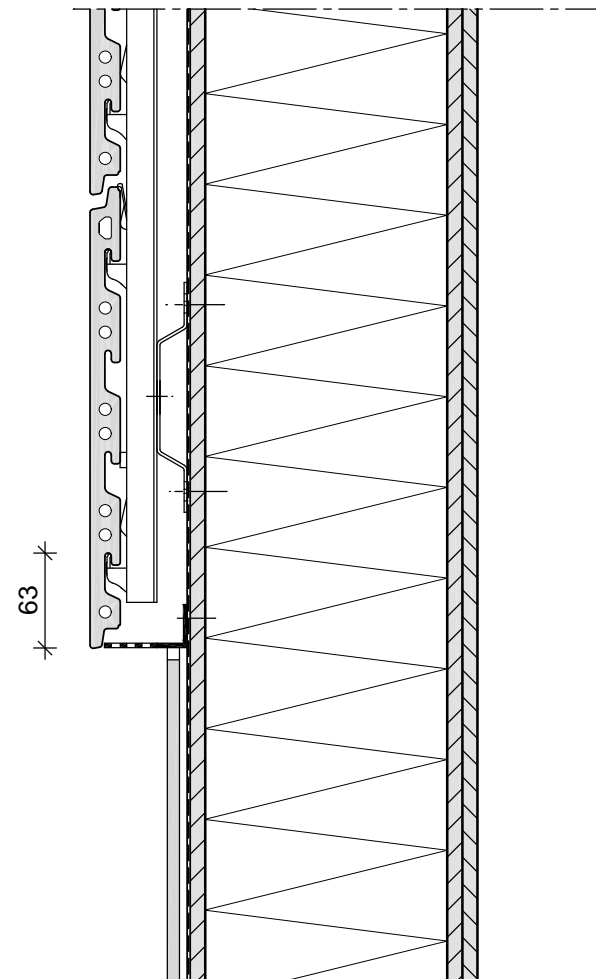

# FENSTERSTURZ

WINDOW LINTEL

LINTEAU DE LA FENETRE

KeraTwin® K20

OMEGAPROFIL AUF HORIZONTALLEM HUTPROFIL

OMEGA SYSTEM RAIL ON HORIZONTAL HAT PROFILE

RAIL SYSTEME OMEGA SUR PROFILE CHAPE HORIZONTAL

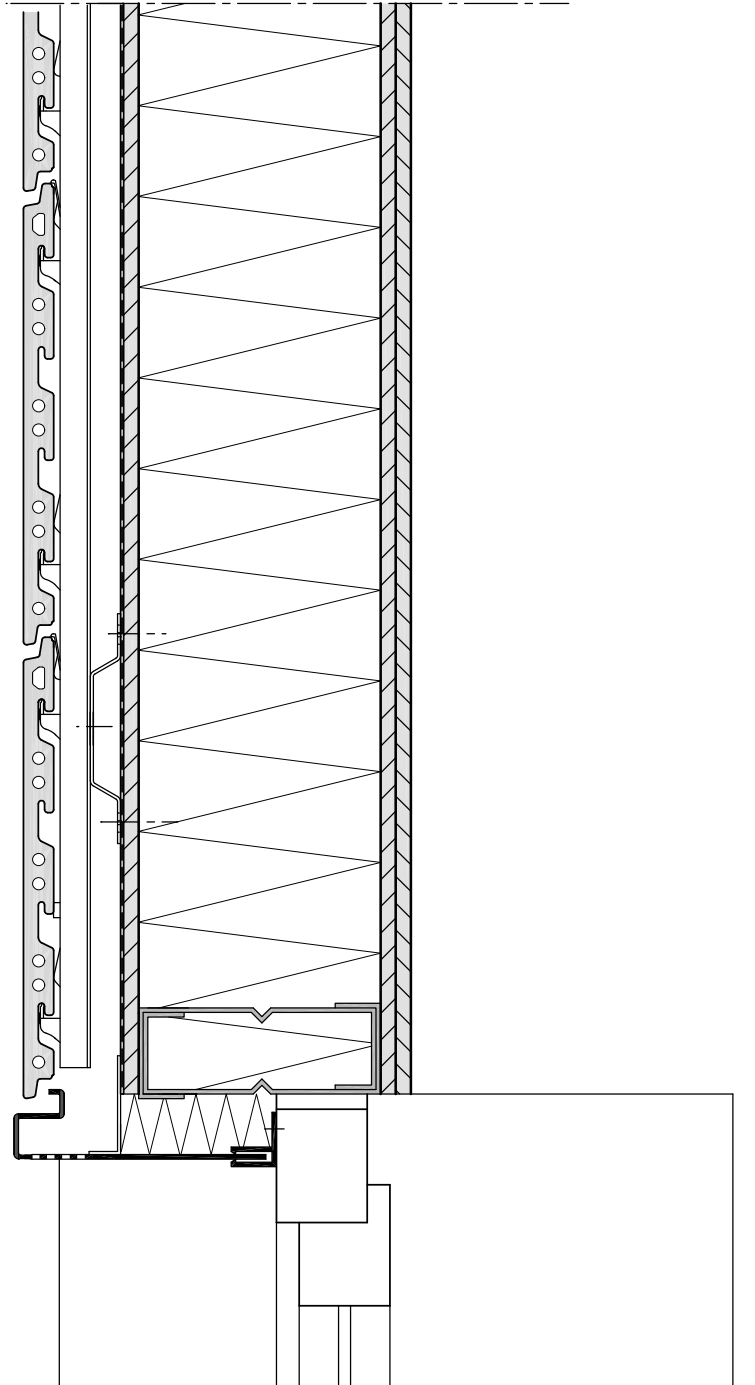

# FENSTERBANK

WINDOW SILL

APPUI DE FENETRE

KeraTwin® K20

OMEGAPROFIL AUF HORIZONTALLEM HUTPROFIL

OMEGA SYSTEM RAIL ON HORIZONTAL HAT PROFILE

RAIL SYSTEME OMEGA SUR PROFILE CHAPE HORIZONTAL

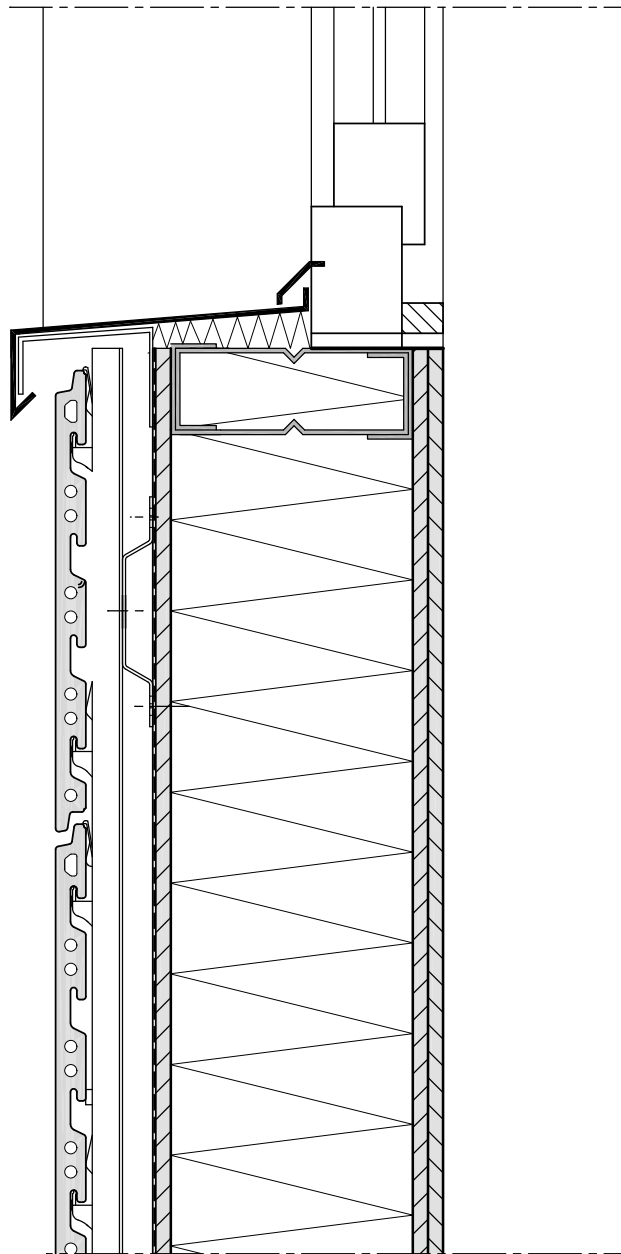

# FENSTERLEIBUNG MIT KERATWIN

WINDOW EMBRASURE WITH KERATWIN  
EMBRASURE DE FENETRE AVEC KERATWIN

KeraTwin® K20

OMEGAPROFIL AUF HORIZONTALM HUTPROFIL  
OMEGA SYSTEM RAIL ON HORIZONTAL HAT PROFILE  
RAIL SYSTEME OMEGA SUR PROFILE CHAPE HORIZONTAL

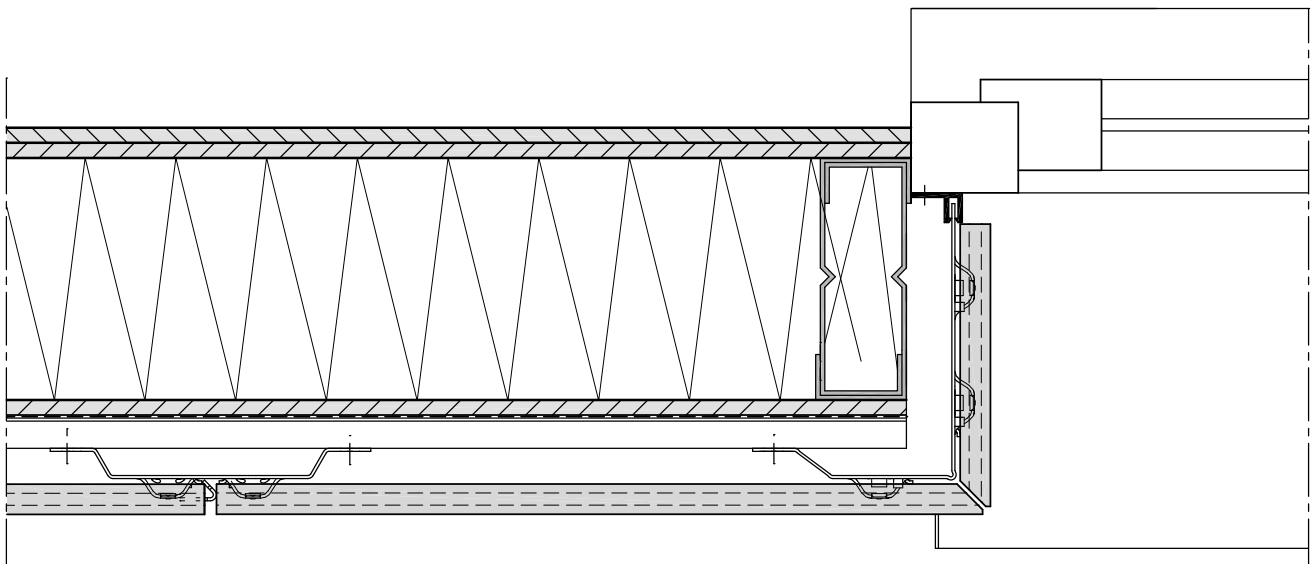

# FENSTERLEIBUNG MIT BLECH

EMBRASURE OF THE WINDOW  
EMBRASURE DE FENETRE

KeraTwin® K20

OMEGAPROFIL AUF HORIZONTALM HUTPROFIL  
OMEGA SYSTEM RAIL ON HORIZONTAL HAT PROFILE  
RAIL SYSTEME OMEGA SUR PROFILE CHAPE HORIZONTAL

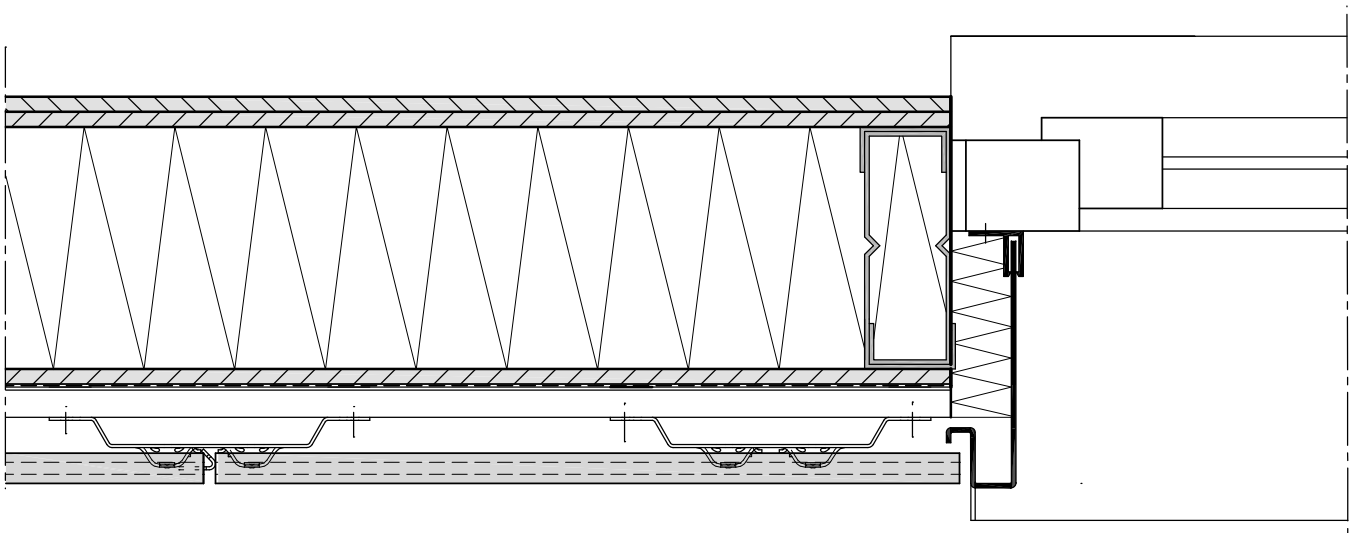

# DACHABSCHLUSS

COVERING OF THE ROOF PARAPET  
RECOUVREMENT D' ATTIQUE

KeraTwin® K20

OMEGAPROFIL AUF HORIZONTALM HUTPROFIL  
OMEGA SYSTEM RAIL ON HORIZONTAL HAT PROFILE  
RAIL SYSTEME OMEGA SUR PROFILE CHAPE HORIZONTAL

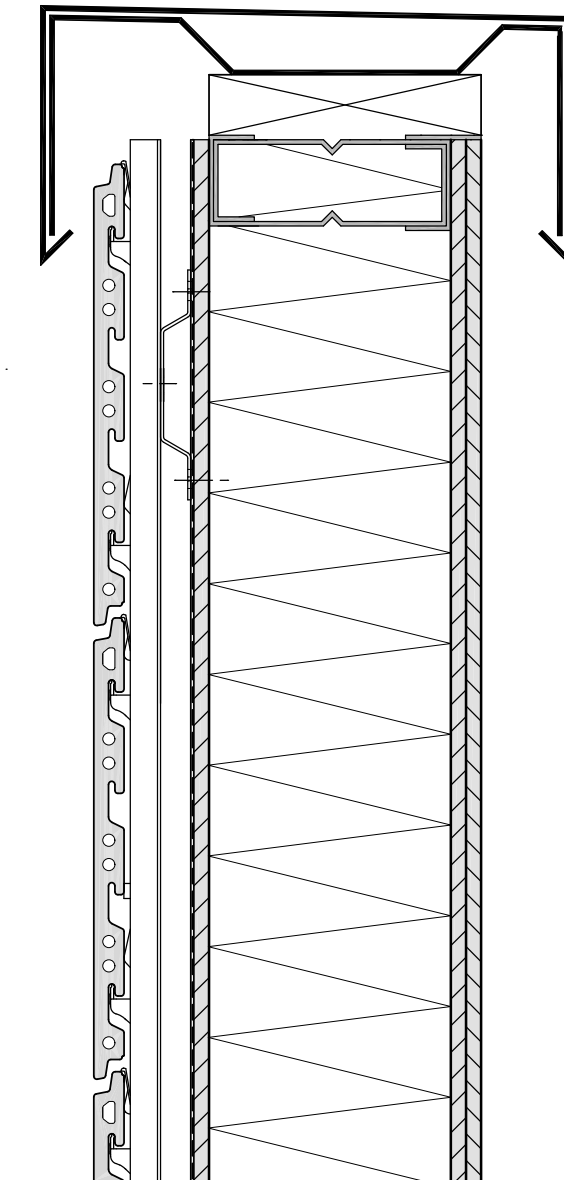

# FUGENPROFIL

JOINT PROFILE  
PROFILE A JOINTS

KeraTwin® K20

OMEGAPROFIL AUF HORIZONTALLEM HUTPROFIL  
OMEGA SYSTEM RAIL ON HORIZONTAL HAT PROFILE  
RAIL SYSTEME OMEGA SUR PROFILE CHAPE HORIZONTAL

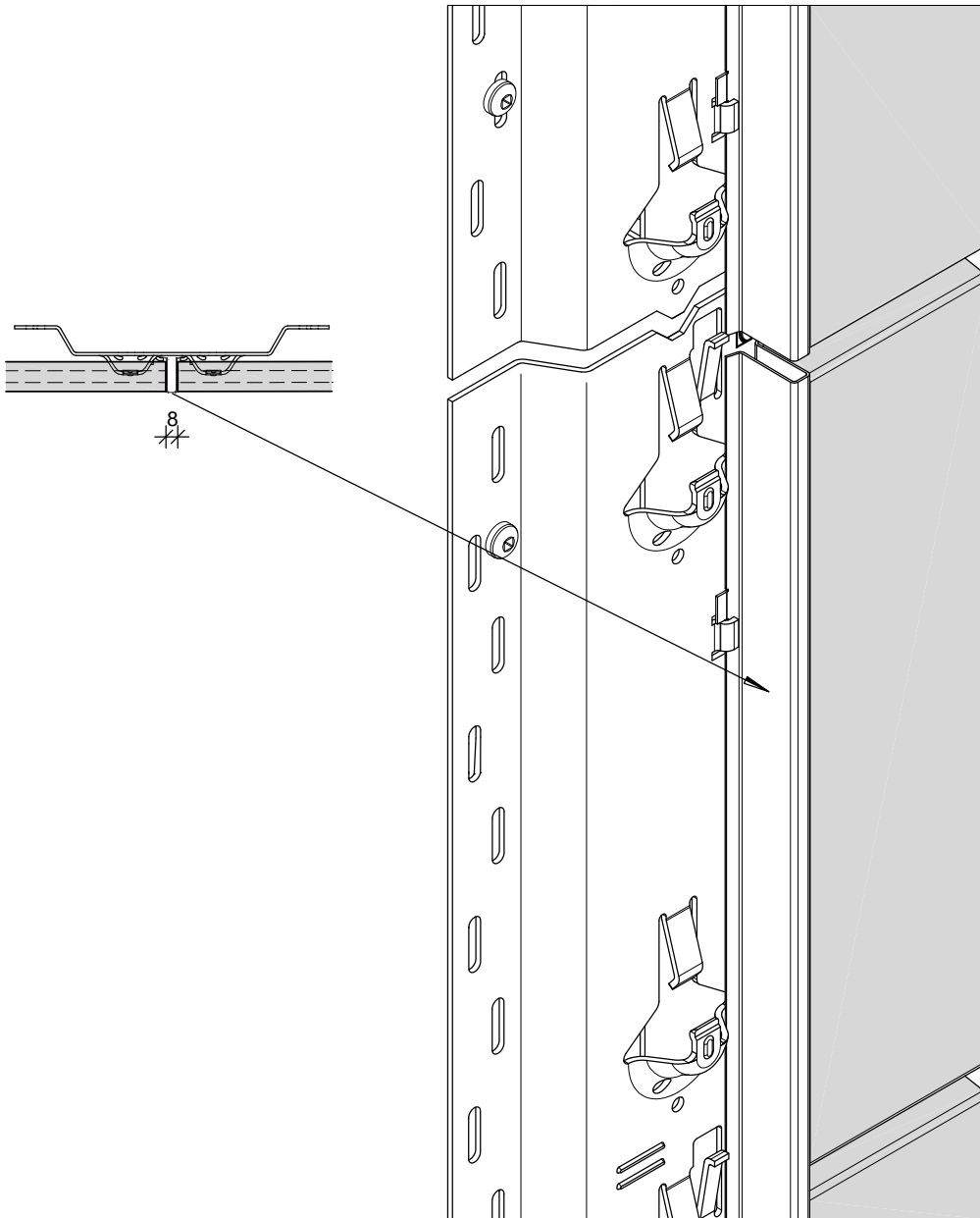

# PROFILSTOSS HORIZONTALS HUTPROFIL

BUTT-JOINT OF HORIZONTAL HAT PROFILE

BOUT DE PROFILE DANS LE PROFILE CHAPE HORIZONTAL

KeraTwin® K20

OMEGAPROFIL AUF HORIZONTALM HUTPROFIL

OMEGA SYSTEM RAIL ON HORIZONTAL HAT PROFILE

RAIL SYSTEME OMEGA SUR PROFILE CHAPE HORIZONTAL

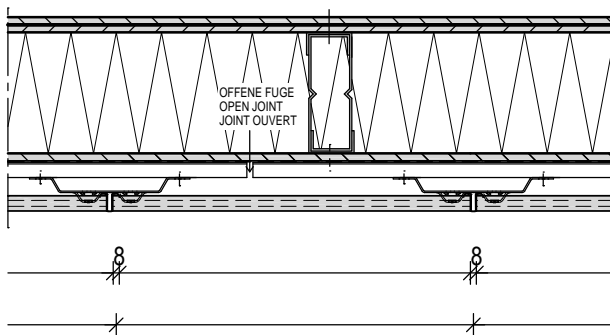
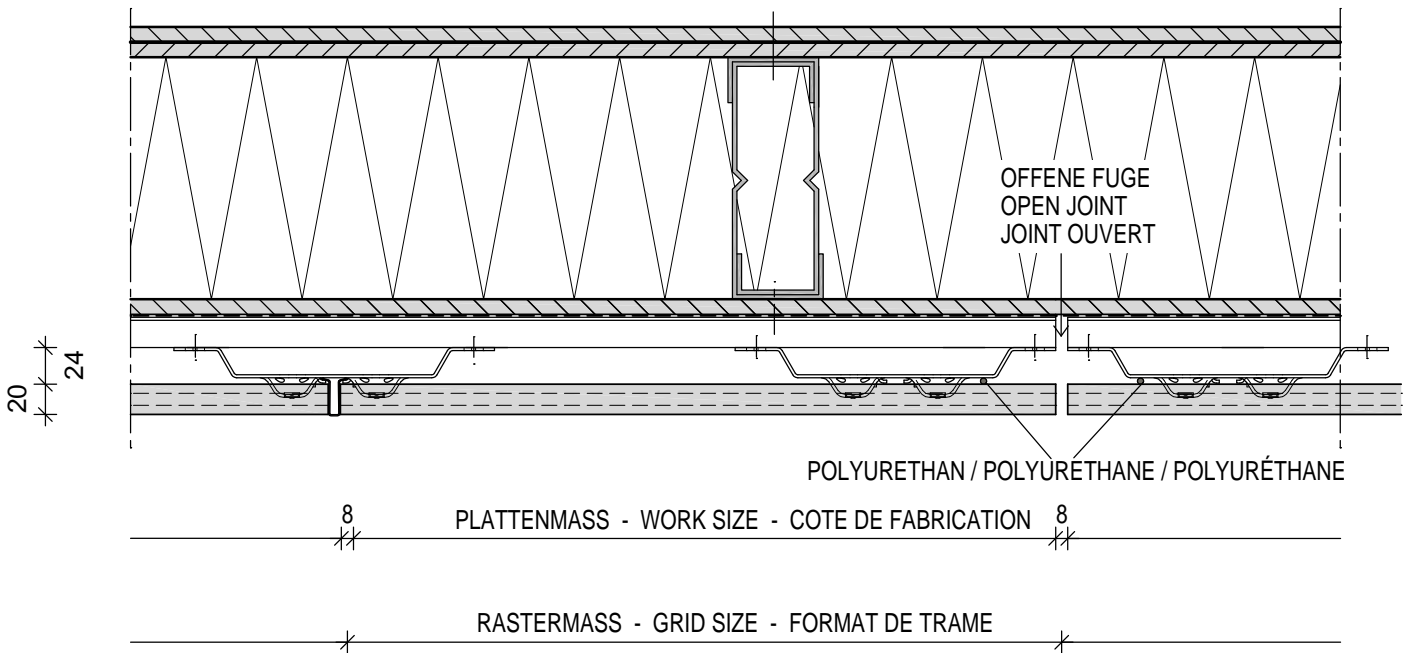

Alternativ  
Alternative  
Alternatif

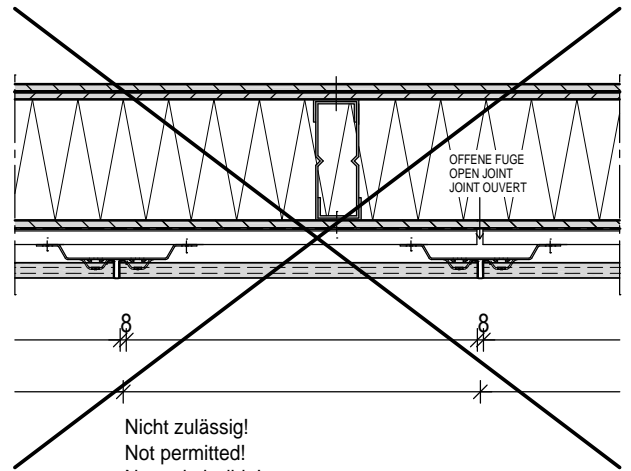

Nicht zulässig!  
Not permitted!  
Non admissible!



# SYSTEMSCHNITT HORIZONTAL

HORIZONTAL SECTION  
COUPE HORIZONTALE

KeraTwin® K20

OMEGAPROFIL AUF HORIZONTALLEM HUTPROFIL  
OMEGA SYSTEM RAIL ON HORIZONTAL HAT PROFILE  
RAIL SYSTEME OMEGA SUR PROFILE CHAPE HORIZONTAL

